

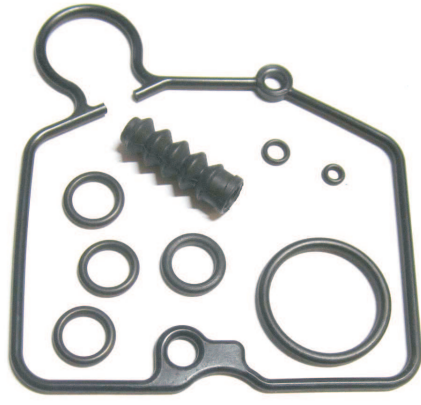

<p>Vergaser-Dichtsatz TM 40</p> <p>V-29775 Vergaser-Dichtsatz TM40 original Mikuni</p>	
<p>V-16261 Schwimmernadel-Set TM 3,8 original Mikuni</p> <p>V-27622 Schwimmernadel-Set TM 3,8 made in Japan</p>	
<p>Vergaser-Dichtsatz TM 42</p> <p>V-31606 Vergaser-Dichtsatz TM42 TM 42-6, HSR 42/45 alt original Mikuni</p> <p>V-36092 Vergaser-Dichtsatz TM42 TM 42-6, HSR 42/45 alt Nachbau</p>	
<p>V-22133 Schwimmernadel-Set TM/HSR 4,2 original Mikuni</p> <p>V-36064 Schwimmernadel-Set TM/HSR 4,2 Nachbau</p>	
<p>Vergaser-Dichtsatz TM 42</p> <p>V-31789 Vergaser-Dichtsatz TM42 TM 42-6, HSR 42/45 alt Nachbau</p>	

Choke Mikuni HSR / TM

- V-24090 Choke Mikuni 1
Staubkappe
- V-24086 Choke Mikuni 2
Verschlußschraube
- V-24088 Choke Mikuni 3
Feder $L=36mm$
- V-24089 Choke Mikuni 4
Kolben $\varnothing=8mm$

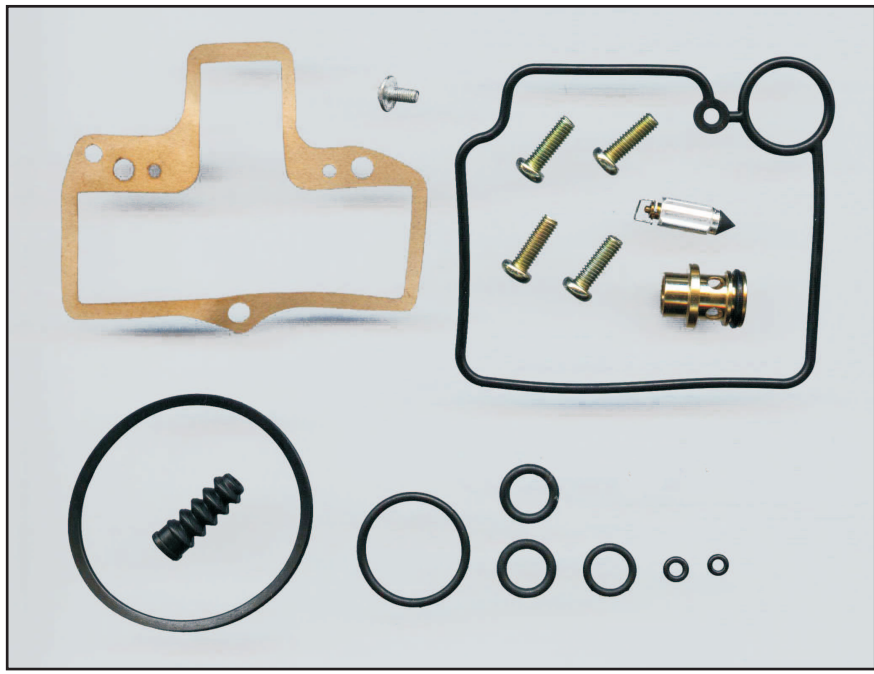
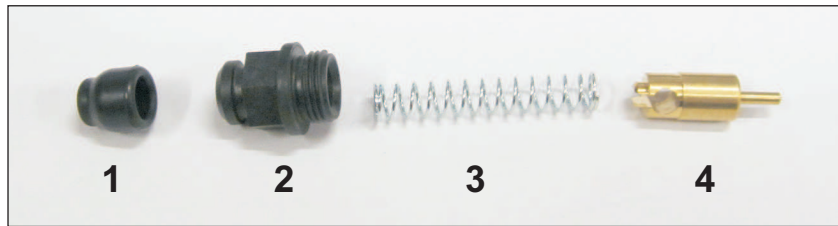

Kolben- \varnothing = 8mm, Kolbenlänge = 17,5mm - gilt für alle untenstehenden Kits

Choke Mikuni TM

- V-35649 Choke-Kit Mikuni 01
- G Gewinde 12mm
- GL Gewindelänge 5,0mm
- L Länge gesamt 19mm

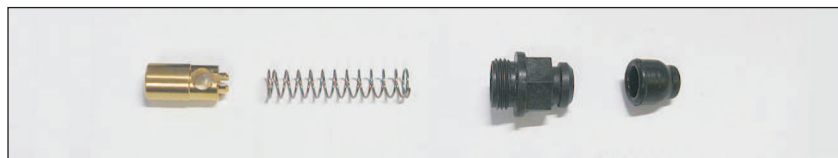

Choke Mikuni TM / VM

- V-35650 Choke-Kit Mikuni 02
- G Gewinde 10mm
- GL Gewindelänge 4,0mm
- L Länge gesamt 21,6mm
- E Einstich + Feder 25,0mm



Unterschied zwischen V-35648 und V-35650 = E

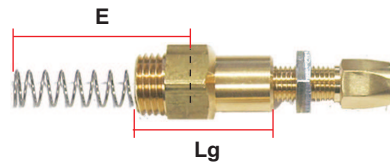

Choke Mikuni TM / TMX / VM

- V-35648 Choke-Kit Mikuni 03
- G Gewinde 10mm
- GL Gewindelänge 4,0mm
- L Länge gesamt 21,6mm
- E Einstich + Feder 29,0mm



Choke Mikuni VM

Umbaukit von E-Choke auf Seilzug

- V-35651 Choke-Kit Mikuni 04
- La Lochabstand 30mm





Zug-Choke Mikuni

Material: Messing / PVC
 Gewinde: M 12, Länge = 5mm
 Schlüsselweite: 14mm
 S Spitz: 8x2mm

V-26851 Zug-Choke Mikuni
 z.B. HSR 42-48

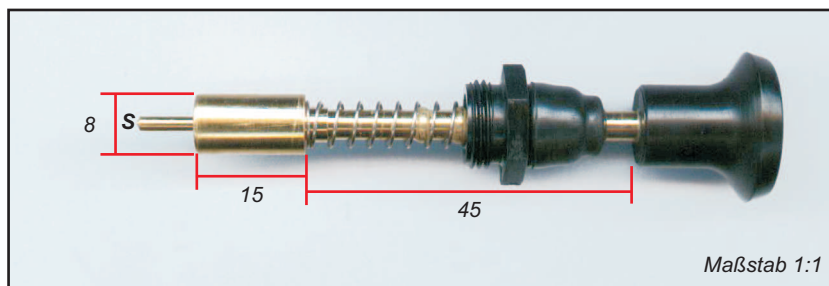

Zug-Choke Mikuni

Material: Messing / PVC
 Gewinde: M 12, Länge = 4mm
 Schlüsselweite: 14mm
 S Spitz: 7x2mm

V-16576 Zug-Choke Mikuni
 z.B. HS 40, TM 36, TM 40

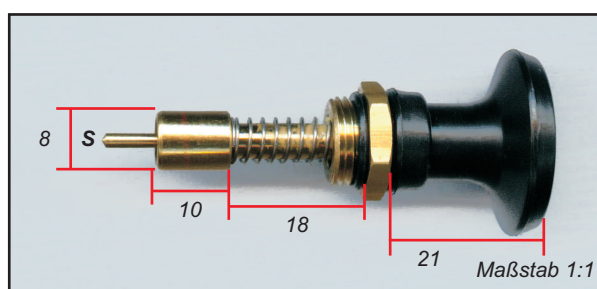

Zug-Choke Mikuni

Material: Messing / PVC
 Gewinde: M 12, Länge = 5mm
 Schlüsselweite: 14mm

V-19499 Zug-Choke Mikuni

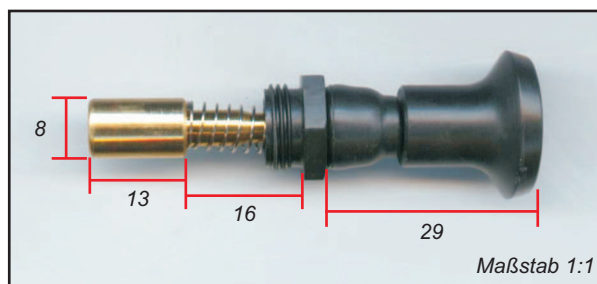

Zug-Choke Mikuni

Material: Messing / PVC
 Gewinde: M 10, Länge = 5mm
 Schlüsselweite: 12mm

V-25311 Zug-Choke Mikuni

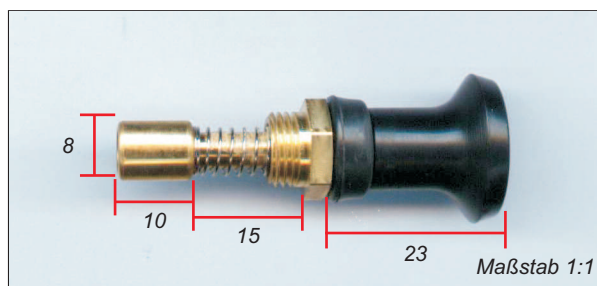

Zug-Choke Mikuni

Material: Messing / PVC
 Gewinde: M 10, Länge = 5mm
 Schlüsselweite: 14mm

V-32560 Zug-Choke Mikuni
 z.B. TM / TMX diverse

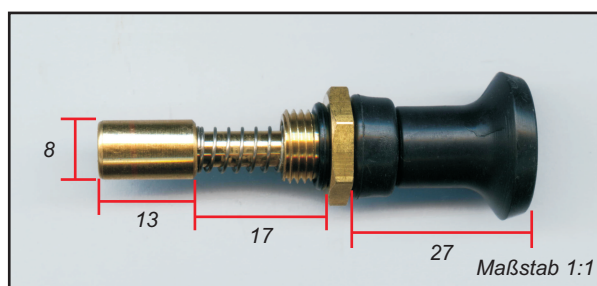



Scheiben für Düsennadel

Material: PVC

Innen-Ø: 3,0mm

V-23495 Scheibe oben
Nr. 5

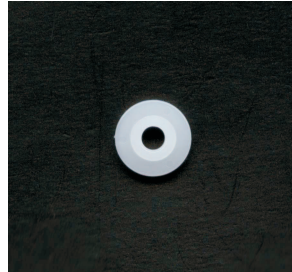

V-23496 Scheibe unten
Nr. 11 Aussen-Ø 6,6mm



V-30993 Scheibe unten
Nr. 11 Aussen-Ø 7,0mm

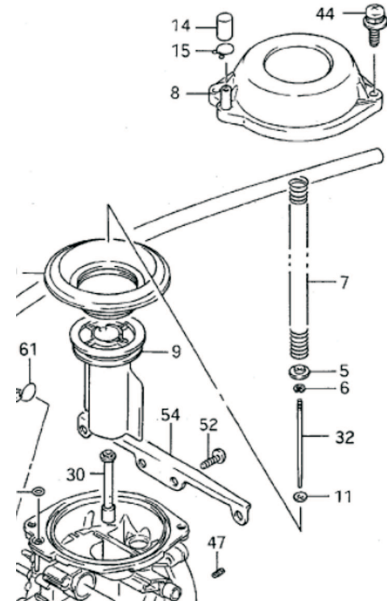

Clip für Schiebernadel

Material: Stahl

V-12584 Nadel-Clip 01



V-32240 Nadel-Clip 02

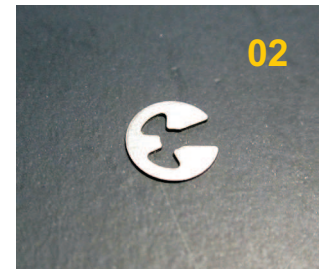

Halter für Schiebernadel

V-36354 Nadelhalter TM(X)
TM27 / TM30 TM(X)



V-37154 Nadelhalter TM
TM36 / TM38





**Benzinanschluss T-Stück
Ducati / Suzuki / Yamaha**

V-32743 T-Stück

V-13997 Gummihülse
1 Stück

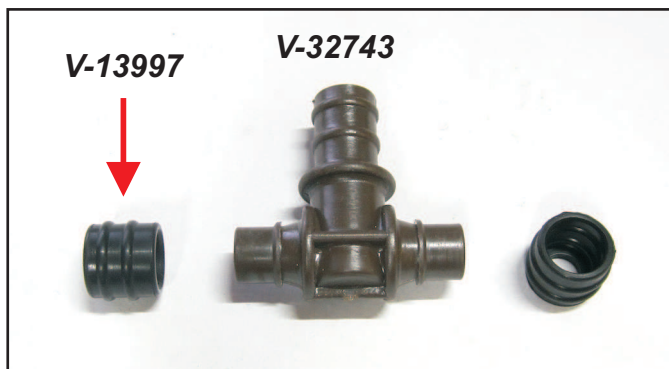

**Belüftungsschlauch T-Stück
Suzuki / Yamaha**

V-28664 T-Stück 18mm

V-35132 T-Stück 24mm

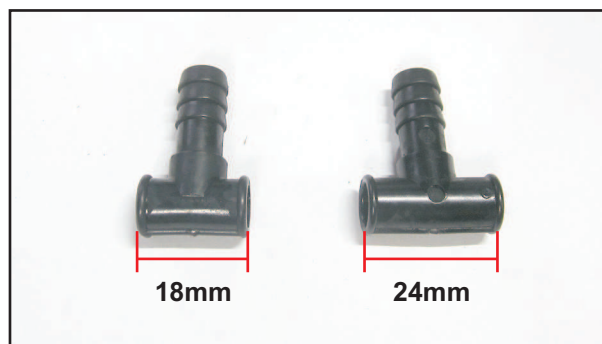

Drosselklappenwellendichtung

V-24249 Dichtung V-Ring
Wellendurchmesser = 8mm



Drosselklappenwellendichtung

V-28914 Dichtung Filzring 01
Wellendurchmesser = 8mm

V-28915 Dichtung Filzring 02
Wellendurchmesser = 10mm



**Stellschrauben VM / Diverse**

V-27139 Stellschrauben-Set
40°



V-24075 Stellschrauben-Set
100°



Auch in der Variante 180° lieferbar

Staubkappen TM / VM

Material: Gummi

V-31564 Staubkappe Gaszug
TM / VM diverse





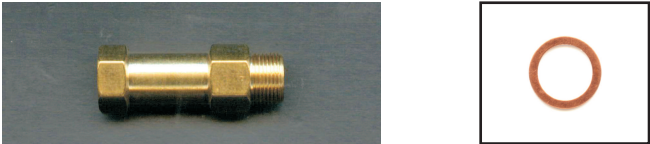

<p>Hauptdüsenhalter</p> <p>V-32825 Hauptdüsenhalter Länge: 24,5mm</p> <p>V-21235 Unterlegscheibe für HD-Halter Abmessungen: 9,5x7,0x0,4mm</p>	 <p style="text-align: right;">Maßstab 1:1</p>
--	--



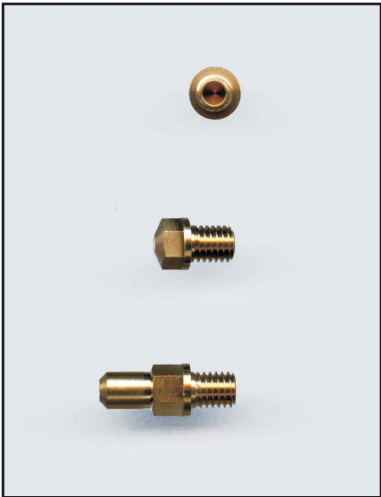



<p>Unterlegscheiben für Hauptdüsen und Hohlschrauben</p> <p>V-15101 Unterlegscheibe ME Material: Messing Abmessungen: 10,0x5,3x1,5mm</p>	 <p style="text-align: right;">Maßstab 1:1</p>
---	--

<p>V-19127 Unterlegscheibe AL Material: Ali Abmessungen: 8,0x5,1x0,9mm</p>	
--	--

<p>Hohlschrauben für Nadeldüsen Material: Messing</p> <p>V-15102 Hohlschraube M5 kurz Länge: 10,5mm</p> <p>V-19033 Hohlschraube M5 lang Länge: 18,0mm</p>	 <p style="text-align: right;">Maßstab 1:1</p>
--	--

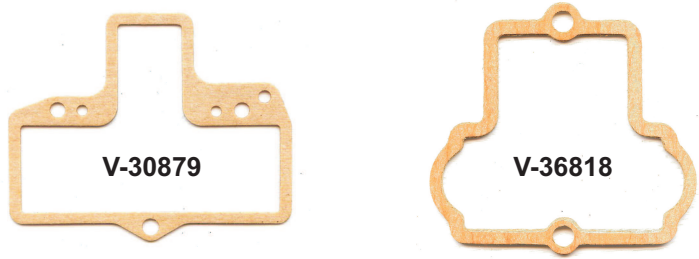
<p>V-32863 Hohlschraube XV / V-MAX</p>	
--	--



<p>Schieberdeckeldichtung TM / TMX Material: Gummi</p> <p>V-21808 Deckeldichtung TM / TMX</p>	 <p style="text-align: right;">Maßstab 1:2</p>
<p>Schieberdeckeldichtung TM / TMX Material: Gummi</p> <p>V-29813 Deckeldichtung TM / TMX</p>	 <p style="text-align: right;">Maßstab 1:2</p>
<p>Schieberdeckeldichtung TM / HSR Material: Papier</p> <p>V-30879 Deckeldichtung TM / HSR</p> <p>V-36818 Deckeldichtung TDMR / TMR</p>	 <p style="text-align: right;">Maßstab 1:2</p>
<p>Schieberdichtung TM / HSR Material: Gummi</p> <p>V-36029 Schieberdichtung TM / HSR TM 42, HSR 42/45/48 44x48x1,8cm</p>	
<p>Düsenblockdichtung TDMR Material: Gummi</p> <p>V-36041 Düsenblockdichtung TDMR</p>	 <p style="text-align: right;">Maßstab 1:1</p>
<p>Düsenblockdichtung TMR Material: Gummi</p> <p>V-36042 Düsenblockdichtung TMR 32-41</p>	 <p style="text-align: right;">Maßstab 1:1</p>
<p>Düsenblockdichtung TMX Material: Gummi</p> <p>V-36043 Düsenblockdichtung TMX 38</p>	 <p style="text-align: right;">Maßstab 1:1</p>



Schwimmer TM / TMX / VM

V-31458 Schwimmeranschlag **01**
TM / TMX / VM diverse
1 Stück

V-31540 Schwimmer **02**
TM / VM diverse
1 Stück

V-35829 Schwimmerarm **03**
TM / VM diverse
1 Stück

V-12234 Schwimmerkammerdichtung **04**
VM 36 - VM 44
1 Stück

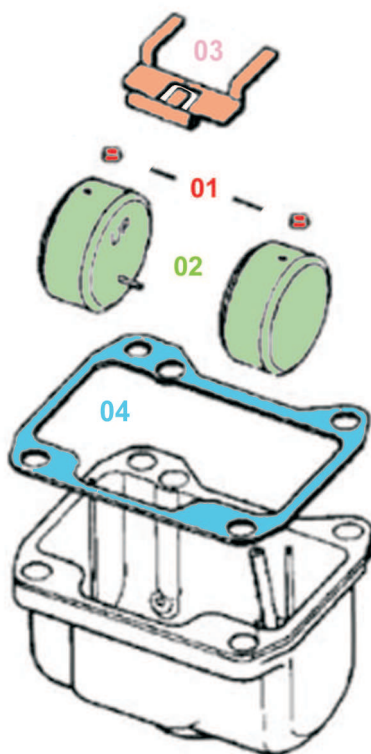

TM32-1
TM34-2
TM36-2
TM38-85

VM36 - VM44

TM32-1
TM32-61
TM34-2
TM35-1
TM36-2
TM38-18
TM38-27
TM38-85
TM38-131
TM38-157

VM36 - VM44

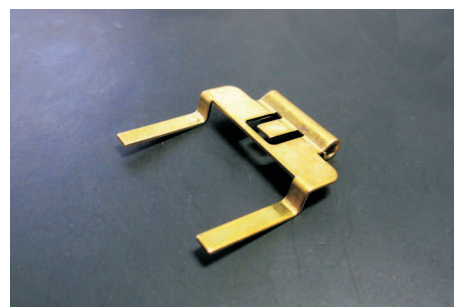

Schwimmerachse Mikuni

Schwimmerachse Mikuni

V-37267 Schwimmerachse MIK
mit Bund

Länge: 27,0mm
Durchm: 2,5mm



**Mikuni RS / HSR / TM**

V-20398 Kolben
für Beschleunigerpumpe

**Mikuni RS / HSR / TM**

V-14039 Faltenbalg
für Beschleunigerpumpe

**Mikuni HSR / TM**

V-32734 Pumpenstange
für Beschleunigerpumpe

Länge: 105mm
Durchmesser: 2,5mm

**Mikuni RS / TM**

V-37302 Gehäusedichtung
TM 36-1 / TM 40-6 / RS

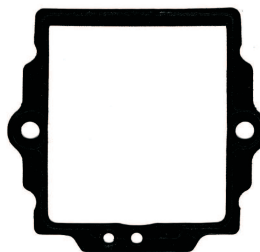

Maßstab 1:2

**Standgasschraube spezial****V-32241 Standgasschraube
mit Feder**

Gewinde: M5x0,5
Gewindelänge: 16mm
Gesamtlänge: 28mm
Kopfdurchmesser: 16mm

