

# Ritzelsicherungen

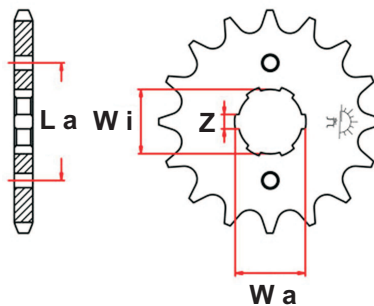

Z Zähneanzahl  
 Zahnbreite  
 Wi Wellen-Ø innen  
 Wa Wellen-Ø aussen  
 La Lochabstand

Abmessungen der Getriebeausgangswelle



Typ	Zähneanzahl	Zahnbreite	Wi	Wa	La	Bestell-Nr.
A 01	6	4	16,0	20,0	34,0	V-27648
A 02	6	4	18,0	20,0	34,0	V-25528
A 03	6	5	17,5	20,0	34,0	V-25527
A 04	6	5	18,0	22,0	35,5	V-25529
A 05	6	5	21,0	25,0	38,0	V-25530
A 09	6	5	21,0	25,0	42,0	V-27650
A 06	6	6	22,0	25,0	41,0	V-25545
A 07	6	6	22,0	25,0	42,0	V-25544
A 08	6	6	23,5	25,5	41,0	V-11950



Typ	Zähneanzahl	Zahnbreite	Wi	Wa	La	Bestell-Nr.
O 01	6	4	16,0	20,0	30,0	V-25531
O 02	6	4	18,0	20,0	32,0	V-27651



Typ	Zähneanzahl	Wi	Wa	Bestell-Nr.
K 01	6	16,0	20,0	V-27640
K 02	6	16,0	20,0	V-27638
K 03	6	18,0	22,0	V-27641



Typ	Zähneanzahl	Wi	Wa	Bestell-Nr.
R 01	6	21,0	25,0	V-27621

# Ritzelsicherungen

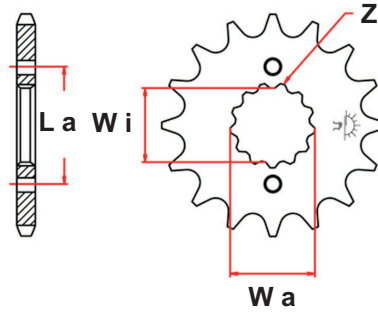

Z Zähneanzahl  
 Wi Wellen-Ø innen  
 Wa Wellen-Ø aussen  
 La Lochabstand

Abmessungen der Getriebeausgangswelle



Typ	Zähneanzahl	Wi	Wa	La	Bestell-Nr.
B 01	11	18,5	22,0	36,0	V-08725
B 02	12	24,0	28,0	44,0	V-22174
B 03	13	21,6	25,0	38,0	V-25543
B 04	13	21,6	25,0	42,0	V-09631
B 05	14	22,0	25,0	38,0	V-25549



Typ	Zähneanzahl	Wi	Wa	La	Bestell-Nr.
P 02	18	22,5	25,0	38,0	V-27647

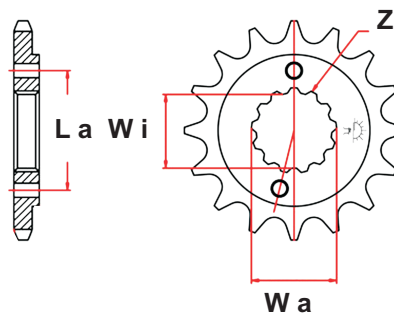

Z Zähneanzahl  
 Wi Wellen-Ø innen  
 Wa Wellen-Ø aussen  
 La Lochabstand versetzt



Typ	Zähneanzahl	Wi	Wa	La	Bestell-Nr.
C 05	13	18,5	22,0	34,0	V-30909
C 04	13	19,5	22,5	38,0	V-27649
C 01	13	21,6	25,0	41,0	V-25550
C 02	17	21,0	23,0	41,0	V-25526
C 03	19	18,0	20,0	34,0	V-27652

# Ritzelsicherungen

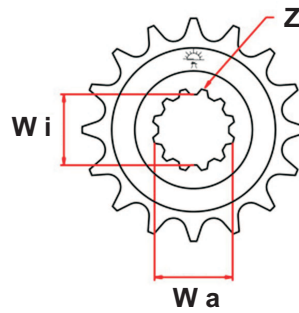

Z Zähnezahl  
 W i Wellen-Ø innen  
 W a Wellen-Ø aussen

Abmessungen der Getriebeausgangswelle

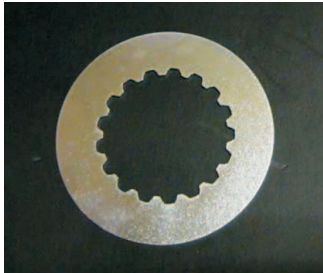

Typ	Zähne- anzahl	W i	W a	Bestell-Nr.
D 05	13	26,0	30,0	V-27639
D 01	14	22,0	25,0	V-25541
D 02	15	22,0	25,0	V-17014
D 03	17	25,0	28,0	V-25542
D 04	18	18,0	20,0	V-25540
D 06	22	22,0	24,0	V-31410



Typ	Zähne- anzahl	W i	W a	Bestell-Nr.
E 01	12	24,0	28,5	V-25537
E 02	13	21,6	25,0	V-17622
E 03	13	21,6	25,0	V-25533
E 06	13	21,6	25,0	V-27646
E 04	13	22,0	25,0	V-25535
E 05	13	26,0	30,0	V-25538



Typ	Zähne- anzahl	W i	W a	Bestell-Nr.
F 01	13	19,5	22,0	V-25534
F 02	13	21,6	25,0	V-25532



Typ	Zähne- anzahl	W i	W a	Bestell-Nr.
S 01	13	21,6	25,0	V-33122

# Ritzelsicherungen

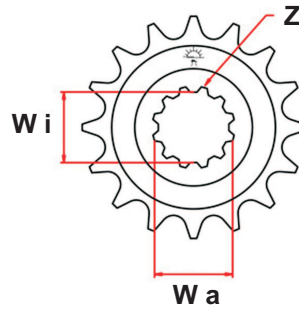

Z Zähneanzahl  
 W i Wellen-Ø innen  
 W a Wellen-Ø aussen

Abmessungen der Getriebeausgangswelle

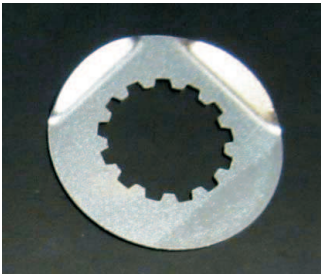

Typ	Zähneanzahl	W i	W a	Bestell-Nr.
G 01	13	21,6	25,0	V-25548



Typ	Zähneanzahl	W i	W a	Bestell-Nr.
M 01	13	21,7	25,0	V-27644
M 02	13	21,7	25,0	V-27645



Typ	Zähneanzahl	W i	W a	Bestell-Nr.
N 01	14	17,7	20,0	V-27642

# Ritzelsicherungen

Abmessungen der Getriebeausgangswelle

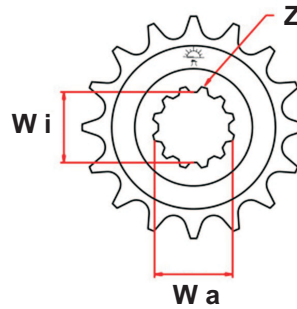

Z Zähnezahl  
W i Wellen-Ø innen  
W a Wellen-Ø aussen

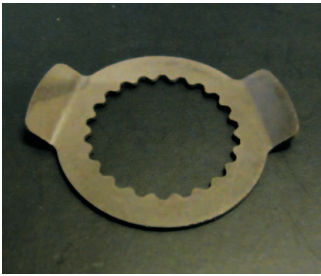

Typ	Zähne- anzahl	W i	W a	Bestell-Nr.
H 01	20	20,0	22,2	V-25018
H 02	22	21,3	23,0	V-12054
H 03	13	21,6	25,0	V-26084
H 04	13	25,0	28,3	V-31494



Typ	Zähne- anzahl	W i	W a	Bestell-Nr.
I 01	13	26,0	30,0	V-25546



Typ	Zähne- anzahl	W i	W a	Bestell-Nr.
L 01	14	17,7	20,0	V-27643



Typ	Zähne- anzahl	W i	W a	Bestell-Nr.
J 01	0		20,0	V-03297



Typ	Zähne- anzahl	W i	W a	Bestell-Nr.
U 01	---	18,5	---	V-35036



Typ	Zähne- anzahl	W i	W a	Bestell-Nr.
T 01	---	22,5	---	V-35001